

INFO

4/2021
www.alcaplast.rs

5. 10. 2021

**NISKI SPOLJNI DRENAŽNI
SISTEM**

**NOVI INDUSTRIJSKI SISTEM
ODVODNJE OD NERĐAJUĆEG
ČELIKA**

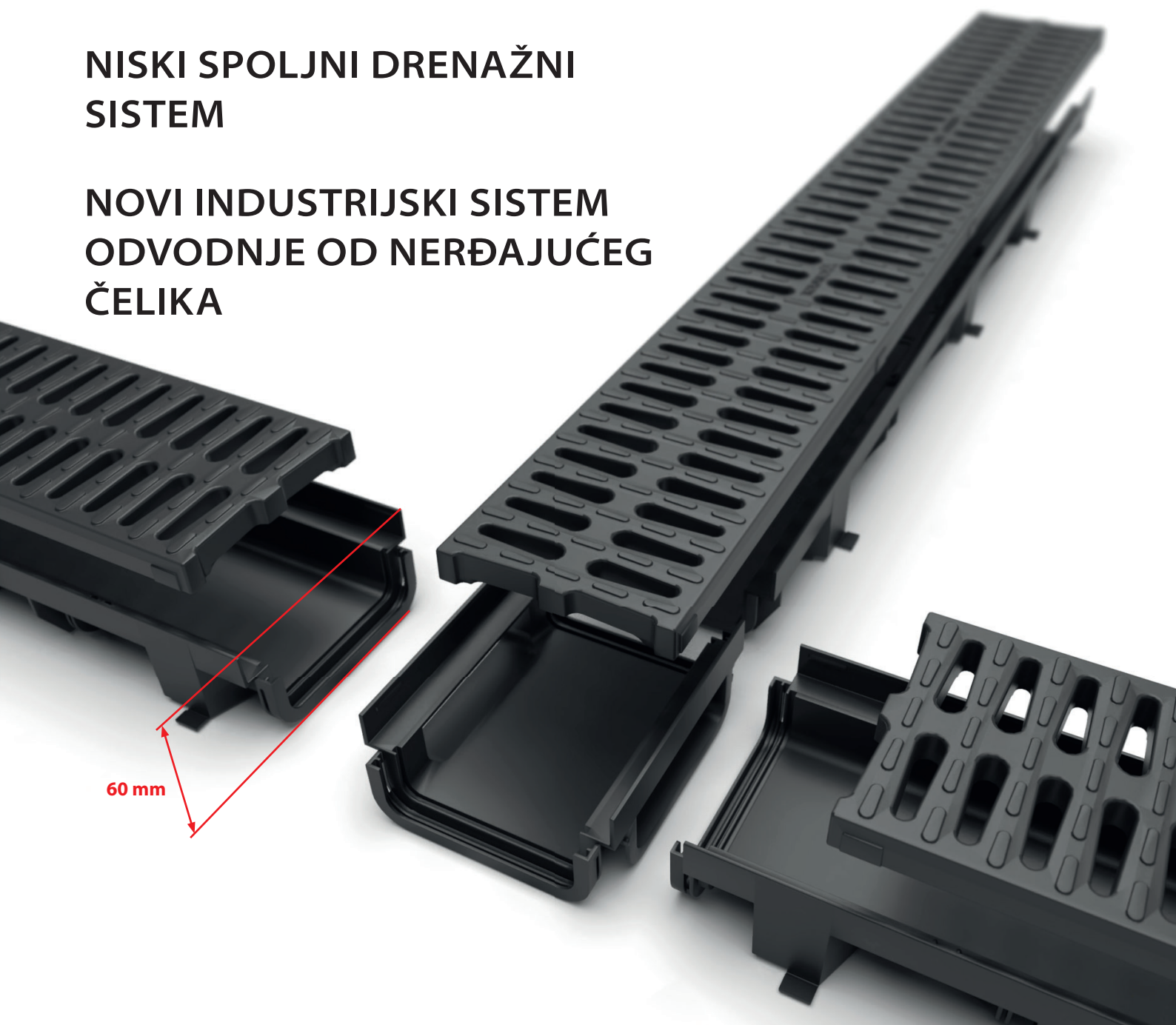

60 mm

NISKI SPOLJNI DRENAŽNI SISTEM	3
--	---



GARAŽNI SET	9
--------------------------	---

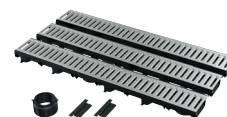

NOVI INDUSTRIJSKI SISTEM ODVODNJE OD NERĐAJUĆEG ČELIKA	11
---	----



WC DASKA ZA OBUKU A68 UNIVERSAL	17
--	----



PROŠIRENJE BLACK-MAT PROGRAMA	18
--	----



CRNA TUŠ KANALICA SA MESINGANOM REŠETKOM APZ10BLACK-BRASS	20
--	----



DVOSTRUKI KONEKTOR P157Z	21
---------------------------------------	----



PREGLED NOVIH PROIZVODA	22
--------------------------------------	----

NOVO

3

NISKI SPOLJNI DRENAŽNI SISTEM

Niski spoljni slivnici sa klasama opterećenja A15 (1,5 t) i B125 (12,5 t) pogodni su za upotrebu oko kuća, za odvodnjavanje pešačkih zona ili na mestima gde je potrebna najmanja moguća dubina ugradnje bez potrebe za višom klasom opterećenja od A15. Telo slivnika je izrađeno od polipropilena, otpornog na mehanička, hemijska i toplotna oštećenja. Mala težina značajno pojednostavljuje rukovanje i ugradnju slivnika.

- **Terase**
- **Porodične kuće, garaže**
- **Spoljašni prostori, parkovi, sportski tereni**

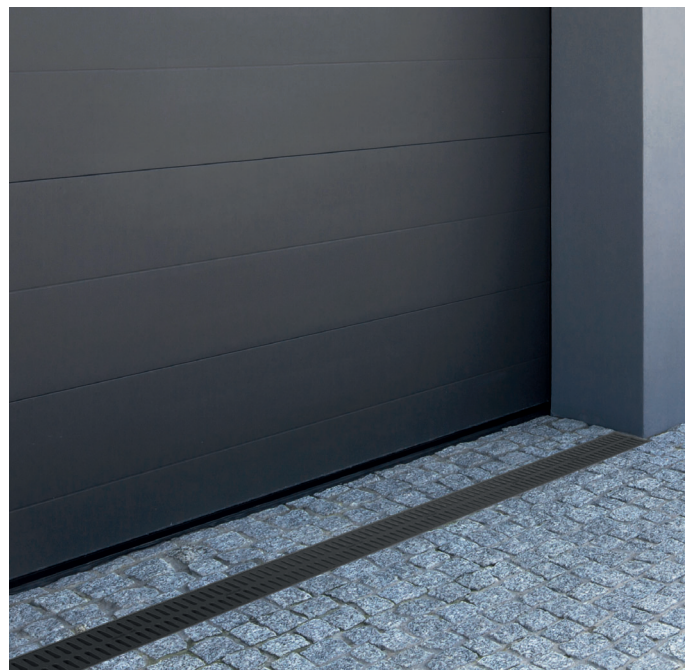

Klasa opterećenja



Klasa opterećenja



Materijal otporan na UV zrake



Materijal otporan na toplotu



Materijal otporan na mraz



Mehanizam za zaključavanje

6

GODINA GARANCJE

NOVO

4

NISKI SPOLJNI DRENAŽNI SISTEM



Smanjena visina ugradnje 60 mm

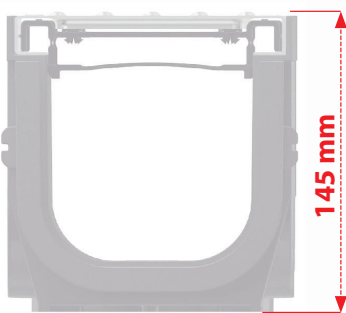

PROFESIONALNI SPOLJNI
DRENAŽNI SISTEMI



NISKI SPOLJNI DRENAŽNI
SISTEM

Dve klase opterećenja, tri materijala

Pocinkovane rešetke

pocinkovana površina sa dužom otpornošću na koroziju.

Plastične rešetke

izrađene od polipropilena vrlo su otporne na mraz, hemikalije i UV zračenje.

Kompozitne rešetke

napravljene od polipropilena napunjenog talkom za veću nosivost

A15



POCINKOVANA
REŠETKA



PLASTIČNA
REŠETKA

B125

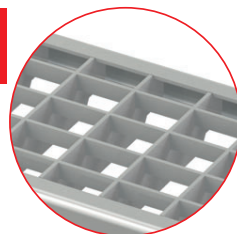

POCINKOVANA
REŠETKA



KOMPOZITNA
REŠETKA

Mehanizam za zaključavanje

Svaki deo slivnika ima na jednom kraju muški konektor i ženski na drugom. Umetanjem muškog konektora u ženski konektor postižetečvrstu vezu. Povezani odvodni kanali drže ravnu liniju.



NOVO

5

NISKI SPOLJNI DRENAŽNI SISTEM

Modularni sistem

Sofisticirani spoljni sistem odvodnje omogućuje jednostavno direktno ili bočno povezivanje i promjenjivo spajanje odvoda i dovoda. Telo slivnika ima standardnu dužinu od 1 m i može se lako skratiti po dužini.

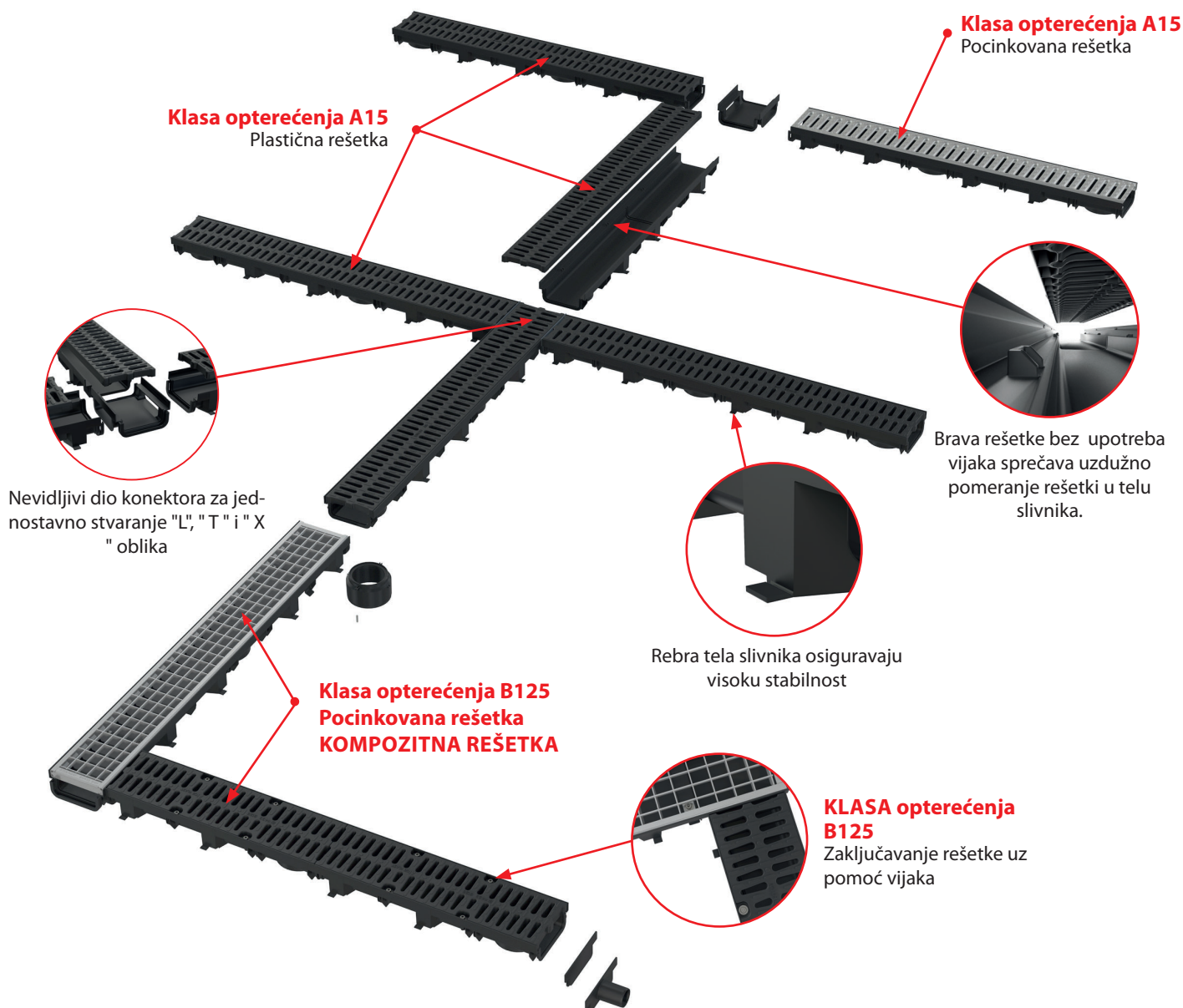

PRIBOR



AVZ-P018

Ulaz vode DN40



AVZ-P017

Čep za zasljepljenje kraja kanalice



AVZ-P016

Utičnica za priključak na odvodnu cev DN110

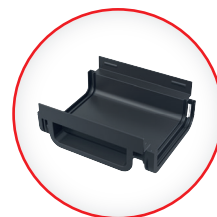

AVZ-P015

Spojni deo spoljnog odvodnog kanala AVZ112

NOVO

6

NISKI SPOLJNI DRENAŽNI SISTEM

GLAVNE PREDNOSTI SKLAPANJA

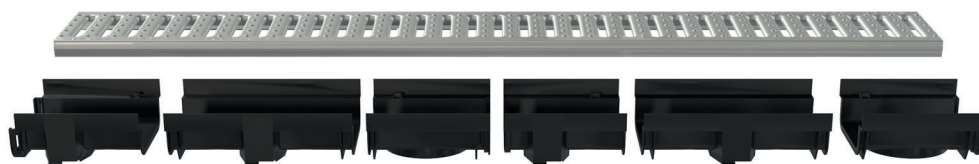

Telo slivnika se može skratiti bilo gde.

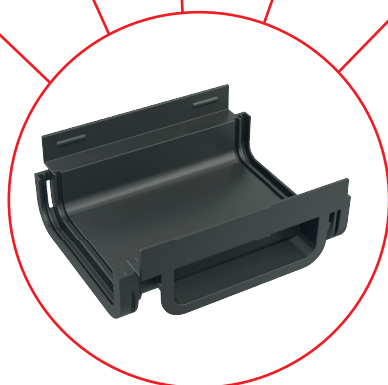

Pet mesta „spremnih za sečenje“ za skraćivanje tela slivnika omogućava korišćenje spojnog dela.



Otvor „spreman za sečenje“ za jednostavno izbijanje i povezivanje tela slivnika.

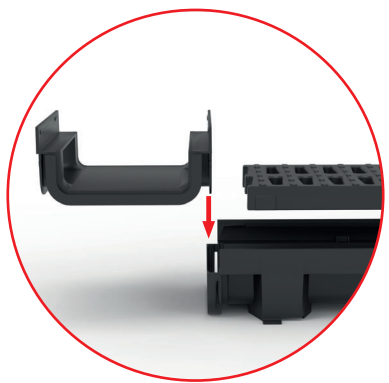

Svaki deo slivnika ima na jednom kraju muški konektor i ženski na drugom. Umetanjem muškog konektora u ženski konektor postižetečvrstu vezu.



Telo slivnika od 0,5 m može biti izrađeno od skraćenog tela slivnika i spojnog dela AVZ-P015.



Telo slivnika od 1 m može biti izrađeno od skraćenog tela slivnika i spojnog dela AVZ-P015.

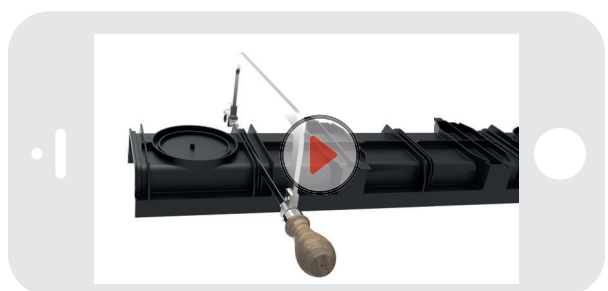

VIDEO INSTALACIJE



NOVO

7

AVZ112-R102

Spoljna kanalica 60 mm sa plastičnim ramom i pocinkovanom "C" rešetkom A15



Količina (pakovanje) AVZ112-R102	1 kom
Dimenzije (komad)	1010×137×60 mm
Težina (komad)	0,8612 kg
EAN	8595580572198

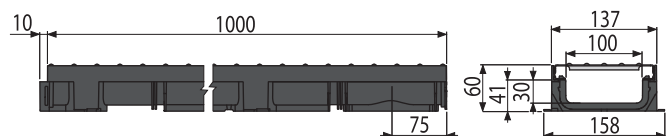

AVZ112-R501

Spoljna kanalica 60 mm sa plastičnim ramom i plastičnom rešetkom A15



Količina (pakovanje) AVZ112-R501	1 kom
Dimenzije (komad)	1010×137×60 mm
Težina (komad)	1,316 kg
EAN	8595580572181



AVZ112-R103

Spoljna kanalica 60 mm sa plastičnim ramom i pocinkovanom rešetkom B125



Količina (pakovanje) AVZ112-R103	1 kom
Dimenzije (komad)	1010×132×137 mm
Težina (komad)	0,8612 kg
EAN	8595580574918

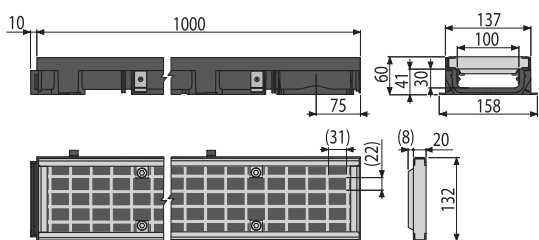

AVZ112-R402

Spoljna kanalica 60 mm sa plastičnim ramom i kompozitnom rešetkom B125

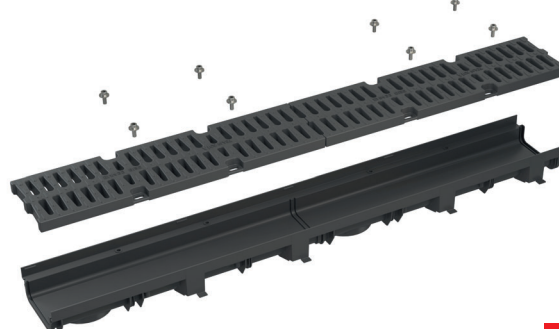

Količina (pakovanje) AVZ112-R402	1 kom
Dimenzije (komad)	1010×132×137 mm
Težina (komad)	1,316 kg
EAN	8595580574925

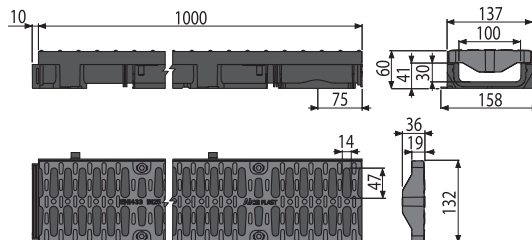

NOVO

8

AVZ-P015

Spojni deo spoljnog odvodnog kanala AVZ112

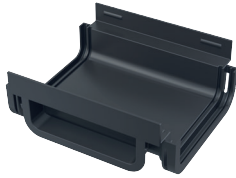

Količina (pakovanje) AVZ-P015	50 kom
Dimenzije (komad)	162×137×60 mm
Težina (komad)	0,1298 kg
EAN	8595580572556

AVZ-P016

Utičnica za priključak na odvodnu cev DN110



Količina (pakovanje) AVZ-P016	50 kom
Dimenzije (komad)	116×116×67 mm
Težina (komad)	0,0954 kg
EAN	8595580572563

AVZ-P017

Čep za zasljepljenje kraja kanalice



Količina (pakovanje) AVZ-P017	200 kom
Dimenzije (komad)	137×53×8 mm
Težina (komad)	0,0211 kg
EAN	8595580572570

AVZ-P018

Ulaz vode DN40



Količina (pakovanje) AVZ-P018	30 kom
Dimenzije (komad)	137×53×60 mm
Težina (komad)	0,053 kg
EAN	8595580572587

NOVO

9

Spoljni drenažni sistem niskog profila LOW – garažni set

↓
A15

Niski spoljni slivnici sa klasom opterećenja A15 mogu se naručiti i kao garažni set od 3 m sa priborom i sa plastičnom ili pocinkovanom rešetkom.

Pakovanje garažnog seta sadrži sve što vam je potrebno za postavljanje niskog spoljnog slivnika oko kuće. Pogodno za kućnu upotrebu oko garaža (područja sa povremenim prelaskom putničkim automobilima), terasa ili ulaza u kuću.

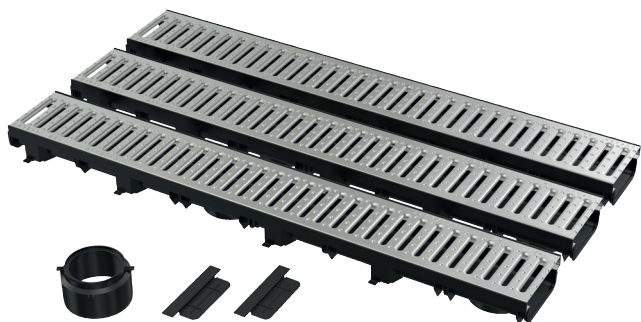

POCINKOVANA REŠETKA

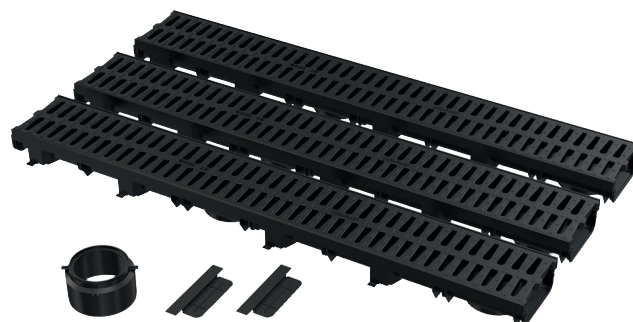

PLASTIČNA REŠETKA

- Praktičan komplet za kućnu upotrebu
- Sve u pakovanju seta
(3 m slivnika, 2 × završna kapa, 1 × utičnica DN110)
- Pogodno za garaže, terase, ulaze u kuće
(sa povremenim prelaskom putničkim automobilima)



6

GODINA GARANCIJE

NOVO

10

AVZ112-G102

Garažni set 3m (2x završni čep, 1x utičnica DN110)

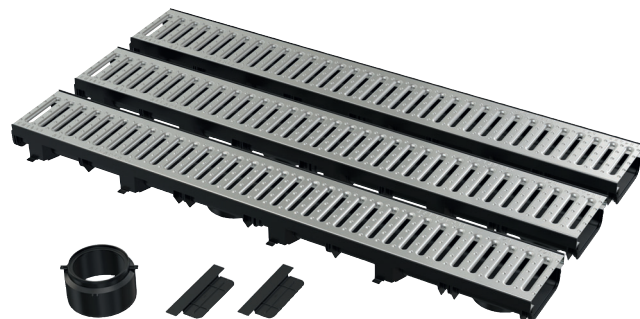
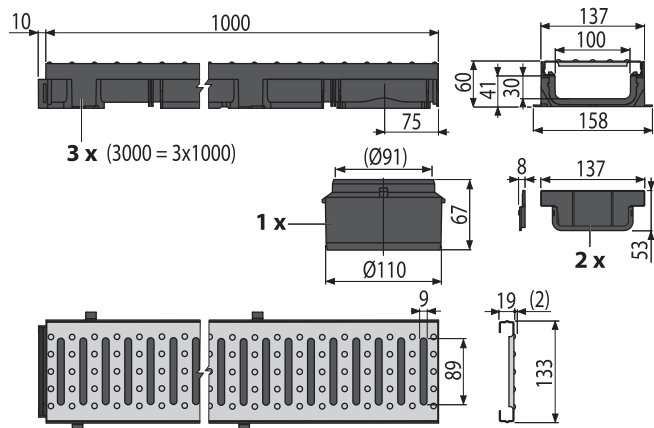

Količina (pakovanje) AVZ112-G102	1 kom
Dimenzije (komad)	1077x180x135 mm
Težina (komad)	0,8612 kg
EAN	8595580573041

A15

AVZ112-G501

Garažni set 3 m (2x završni čep, 1x utičnica DN110)

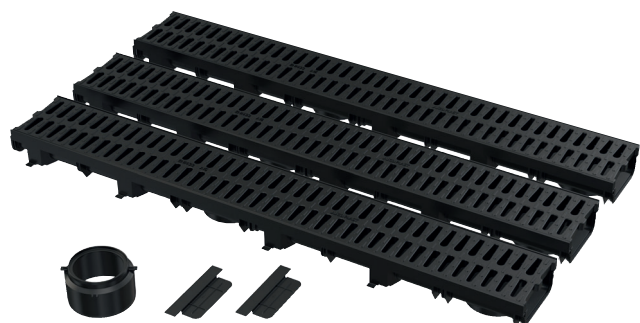
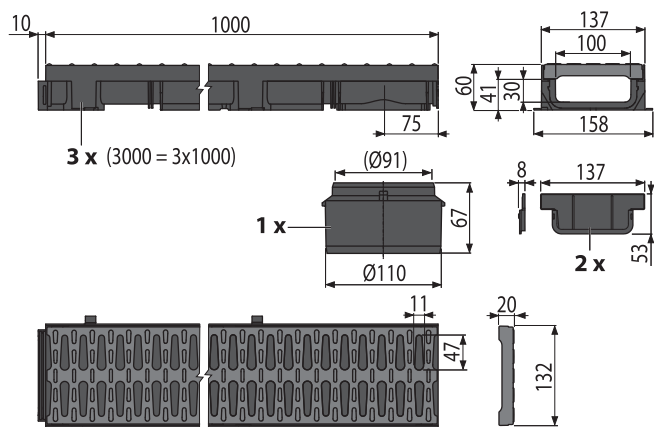

Količina (pakovanje) AVZ112-G501	1 kom
Dimenzije (komad)	1077x180x135 mm
Težina (komad)	1,316 kg
EAN	8595580573058

A15

NOVO

11

NOVI INDUSTRIJSKI SISTEM ODVODNJE OD NERĐAJUĆEG ČELIKA

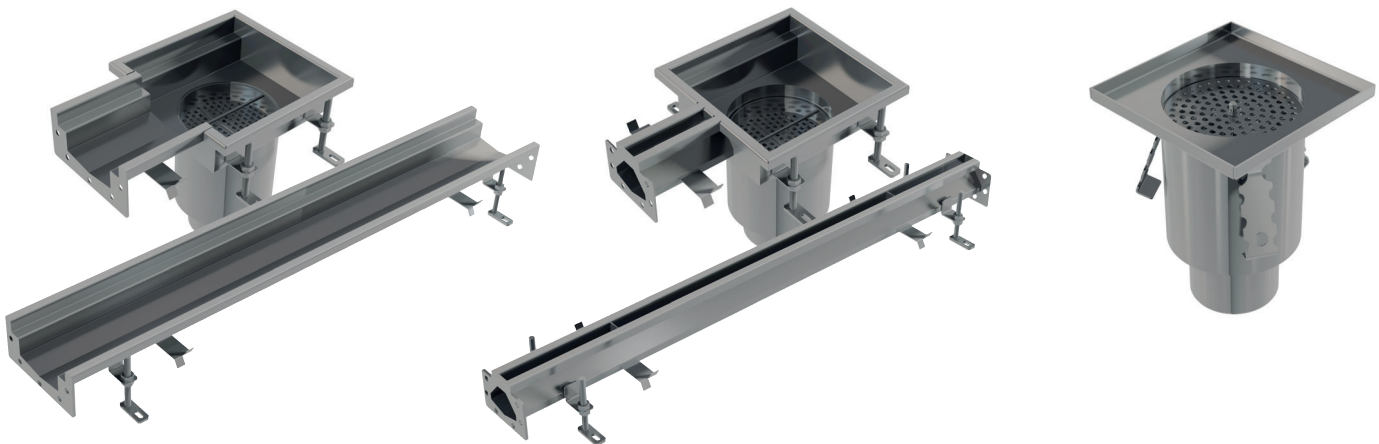
**KUTIJASTI
SLIVNICI**
**PROREZANI
SLIVNICI**
**TAČKASTI
SLIVNICI**

Inox kockasti i prorezani drenažni kanali su dizajnirani za odvodnju velikih industrijskih i drugih tehničkih prostorija i prehrambenoj industriji. Industrijski slivnici se proizvode kao standardizovani delovi koji se mogu upotrebiti za dovršavanje željenog sistema odvodnje. Ako nije moguće koristiti standardne komponente, možemo proizvesti prilagođene dužine i rešenja prema zahtevima kupaca.



- **Proizvodi po meri**
- **Dve vrste rešetke od nerđajućeg čelika za industrijske tačkaste i kutijaste slivnike**
 - Neklizajuća pokrivna rešetka (klasa opterećenja A15, debljina materijala 2 mm)
 - Pokrivna rešetka pogodna za prelaz viljuškarima (klasa opterećenja B125, debljina materijala 5 mm)
- **Materijal nerđajući čelik AISI 304, AISI 316L**
- **Produžena garancija 5 godina**

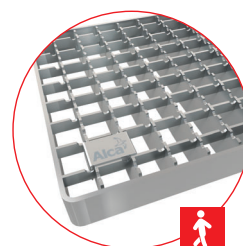

MREŽASTA REŠETKA

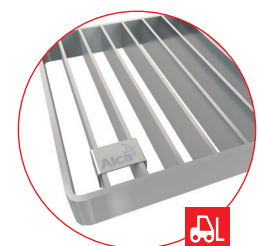

GRIL REŠETKA

5

GODINA GARANCJE



NOVO

12

KOCKASTI SLIVNICI

- Dve varijante širine tela kutijastog slivnika 135 i 210 mm
- Telo kutijastog slivnika bez nagiba
- Industrijski tačkasti slivnik sa 1 ili 2 ulaza i priborom
- Osnovna dužina slivnika 1 m

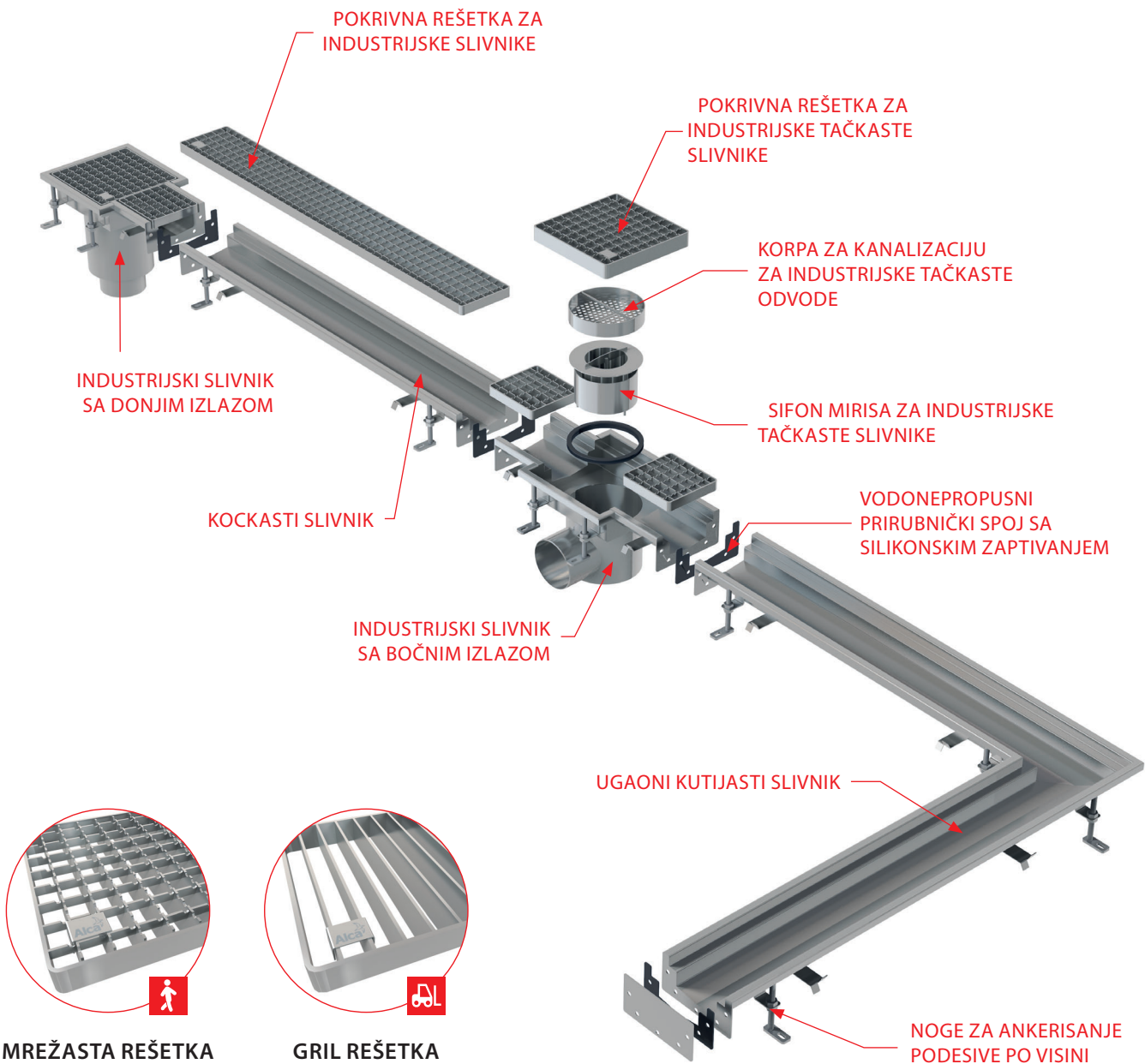
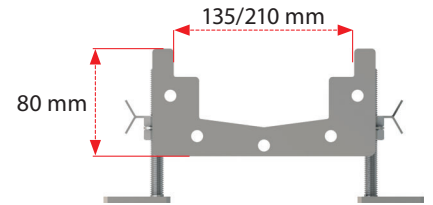

5
GODINA GARANCJE



NOVO

13

PROREZANI SLIVNICI

- Veličina otvora 20 mm
- Industrijski tačkasti slivnik sa 1 ili 2 ulaza i priborom
- Linearna i ugaona odvodna tela
- Osnovna dužina slivnika 1 m

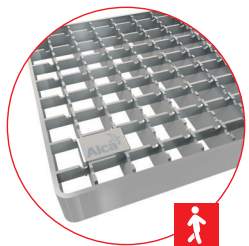
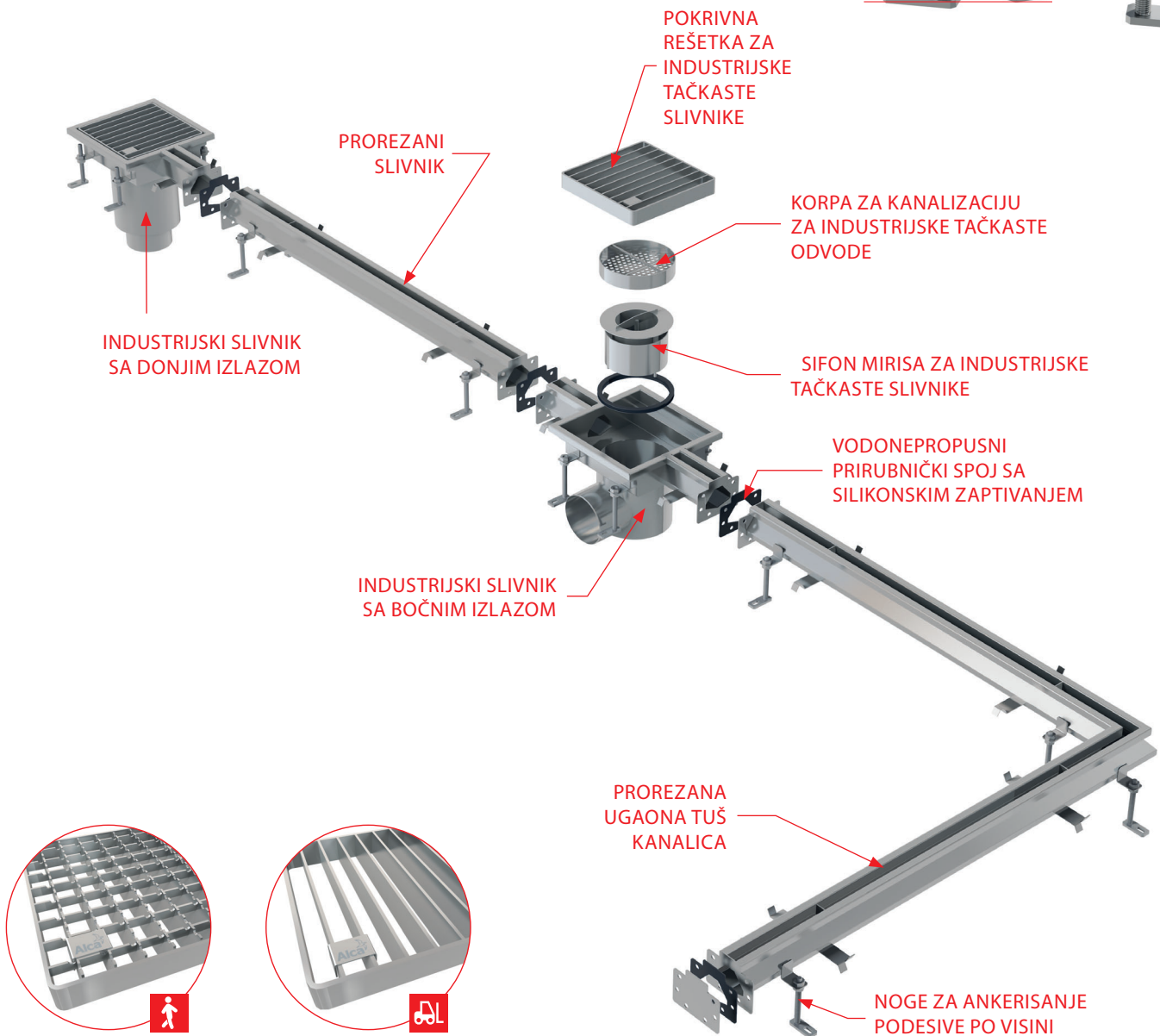
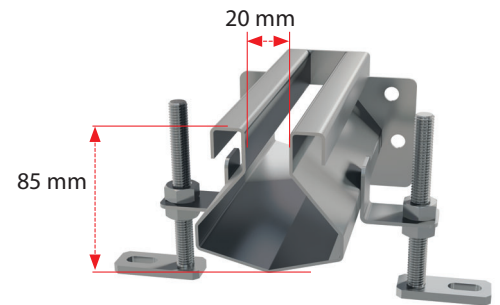

MREŽASTA REŠETKA

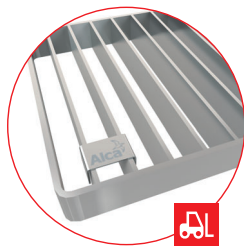

GRIL REŠETKA



NOVO

14

TAČKASTI SLIVNICI

- Industrijski tačkasti slivnici sa 1 ili 2 ulaza ili bez ulaza
- Horizontalni ili vertikalni izlaz
- Visoka brzina protoka osigurana je zahvaljujući tri prečnika izlaza slivnika

150×150 mm



208 mm

DN/OD 75

200×200 mm



233 mm

DN/OD 110

300×300 mm



270 mm

DN/OD 160



149,5 mm

DN/OD 75

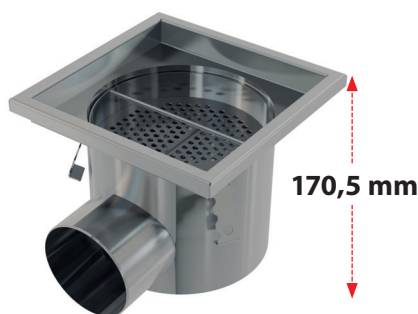

170,5 mm

DN/OD 110



180 mm

DN/OD 110

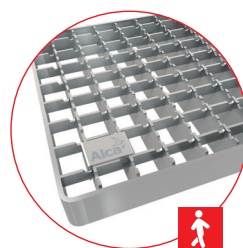

MREŽASTA REŠETKA

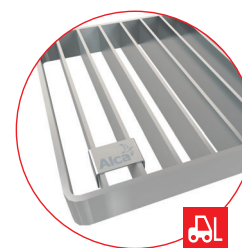

GRIL REŠETKA

5

GODINA GARANCIJE



NOVO

15

Industrijski slivnici - proizvodnja po meri

Atipična dužina

- Maksimalna dužina tela 1 kutijastog slivnika je 2,5 m (standard je 1 m)



- Maksimalna dužina tela 1 prorezanog slivnika je 1,3 m (standard je 1 m)



Tela slivnika sa nagibom maksimalne dužine 12 m u jednoj liniji

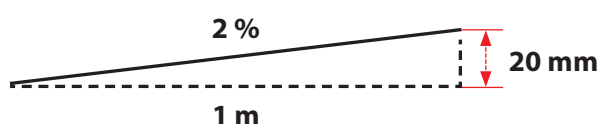

Smanjena visina ugradnje

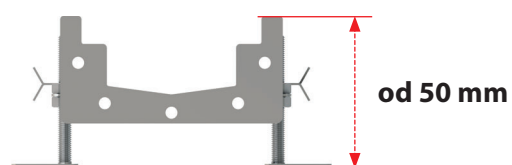

Priključak na posebne oblike "X", "T", "L"

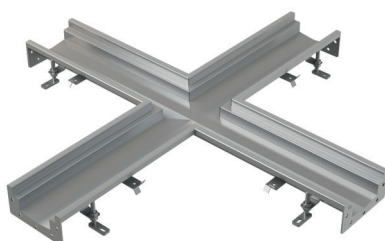

NOVO

16

Industrijski slivnici - proizvodnja po meri

Pet varijanti rešenja oboda

- Rubove delova prilagođavamo pojedinačno potrebnom okruženju
- Posebno rešenje za vinilne podove male visine

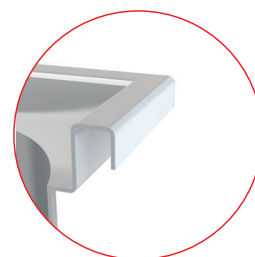
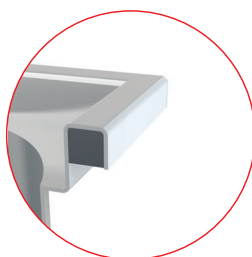

Obod sa ojačanjem

Varijanta za područja velikog opterećenja

Obod bez pojačanja

Varijanta za područja sa malim opterećenjem

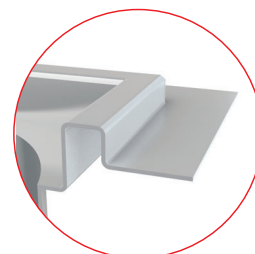
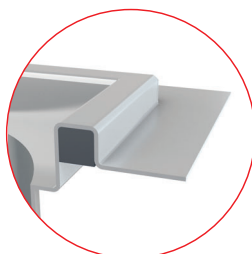

Obod sa ojačanjem i produženim resama

Varijanta za područja velikog opterećenja s opcijom povezivanja hidroizolacije

Obod bez ojačanja, ali sa produženim rubom

Varijanta za područja bez velikog opterećenja, ali sa opcijom povezivanja hidroizolacije

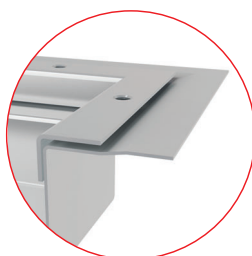

Obod za vinil

Specijalna varijanta za upotrebu sa vinil podom

NOVO

17

WC daska za obuku A68 UNIVERSAL

- Antibakterijski površinski tretman
- Univerzalna upotreba na wc daskama
- Novo pakovanje u štampanoj vrećici



ČEŠKI PROIZVOD



NOVO

18

PROŠIRENJE PROGRAMA BLACK-MAT

Ponovno proširujemo asortiman crno-mat proizvoda. Osim inox ili plastičnih tuš kanalica, sada možete koristiti crni podni slivnik za odvodnjavanje iz kupatila ili drugih prostora u kući. Podni slivnici su sa bočnim izlazom (**APV31BLACK**) ili donjim izlazom (**APV32BLACK**), oba sa kombinovanim sifonom SMART i rešetkom od nerđajućeg čelika od crnog mat-a. Crno-mat rešetka može se koristiti za već ugrađene podne slivnike (**MPV004-BLACK**).

A396BLACK odvod umivaonika je dizajniran za specijalne tipove umivaonika bez preliva napravljenih od keramike, plastike ili stakla. Ovaj čep ne zatvara izlaz, čime se štiti od neželjenog prelivanja vode umivaonika.

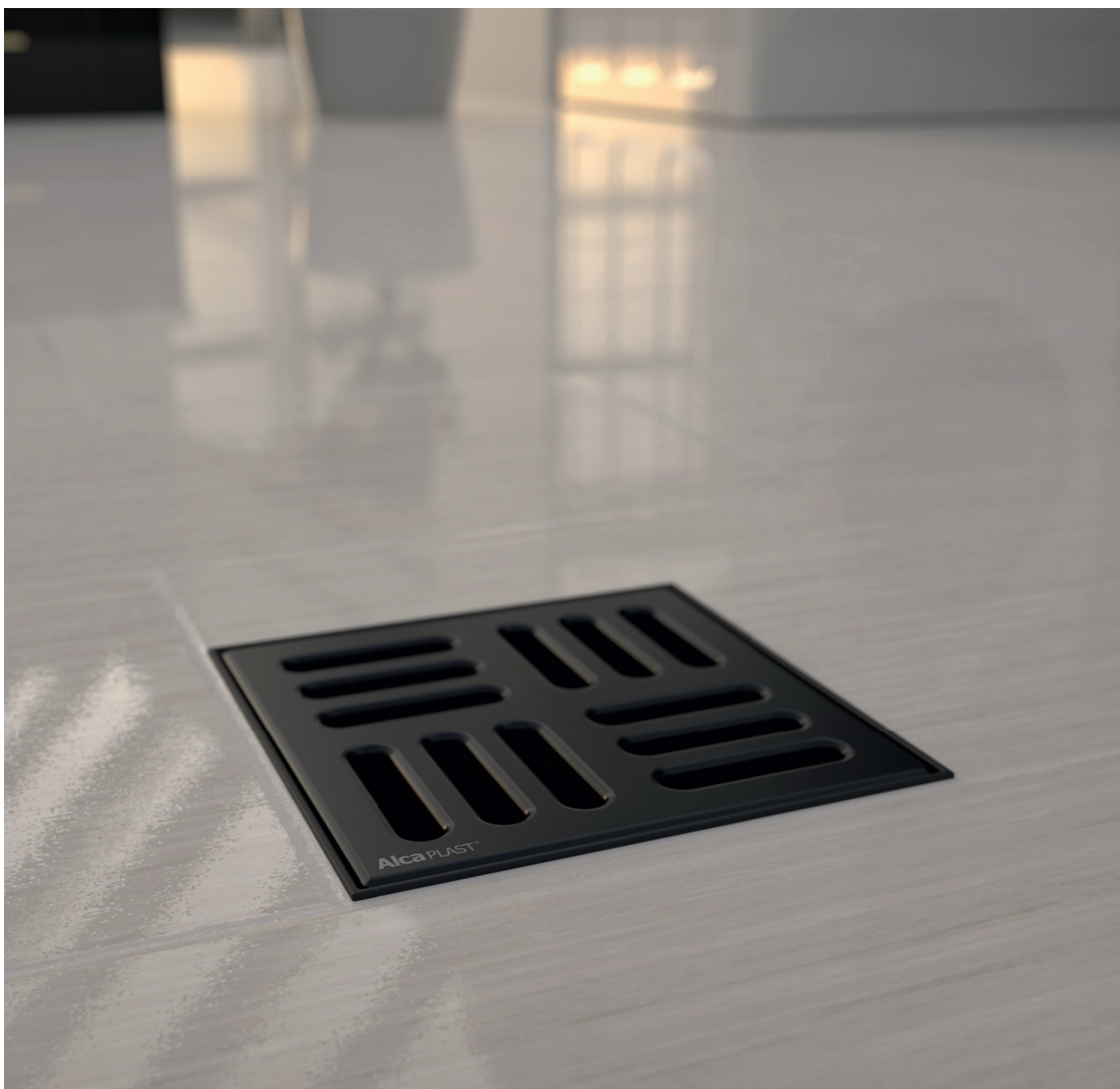

NOVO

19

APV31BLACK

Podni slivnik 105×105/50 mm bočni, nerđajuća rešetka crna-mat, sifon sa zatvaračem mirisa SMART

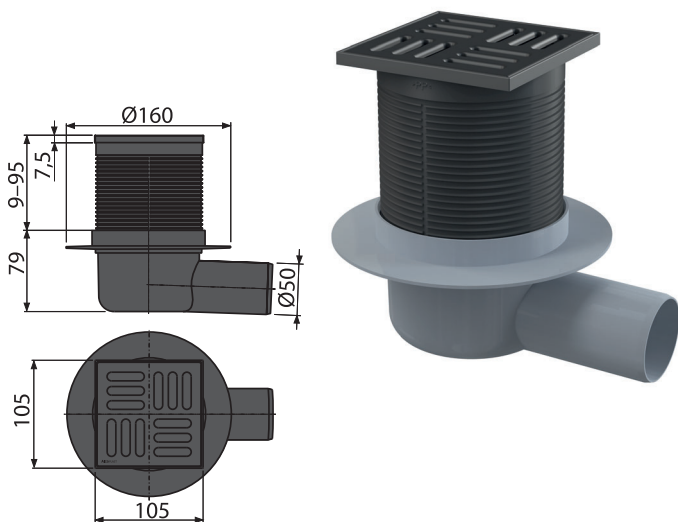

Količina (pakovanje) APV31BLACK	20 kom
Dimenzije (komad)	160×160×88 mm
Težina (komad)	0,4716 kg
EAN	8595580572198

APV32BLACK

Podni slivnik 105×105/50 mm vertikalni spoj, nerđajuća rešetka crna-mat, sifon sa zatvaračem mirisa SMART

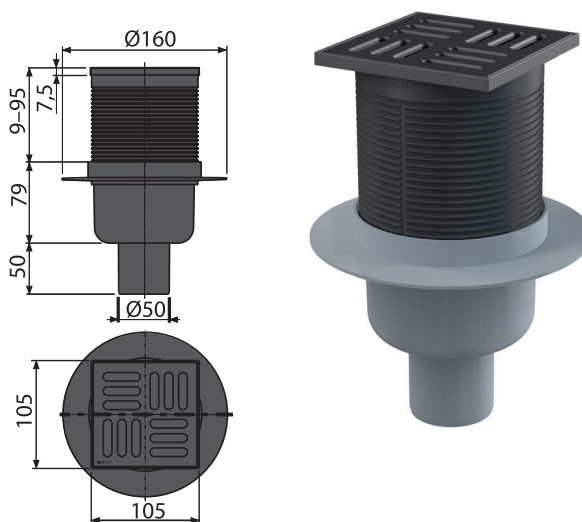

Količina (pakovanje) APV32BLACK	20 kom
Dimenzije (komad)	160×160×138 mm
Težina (komad)	0,4525 kg
EAN	8595580572181

MPV004-BLACK

Rešetka 102×102 mm nerđajući čelik, crna-mat

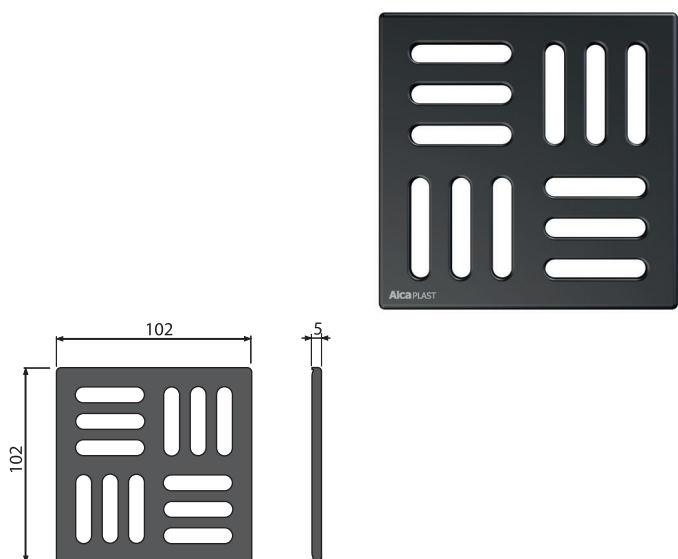

Količina (pakovanje) MPV004-BLACK	1 kom
Dimenzije (komad)	106×106×7 mm
Težina (komad)	0,1215 kg
EAN	8595580574734

A396BLACK

Gornji deo sifona za umivaonik 5/4" metalni, veliki čep, za umivaonike bez preliva crna-mat

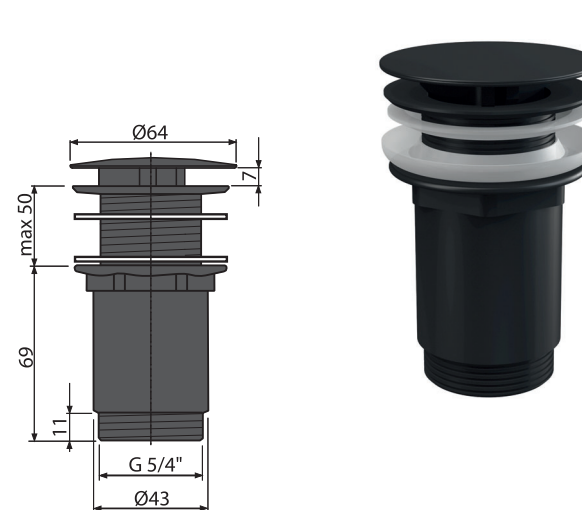

Količina (pakovanje) A396BLACK	30 kom
Dimenzije (komad)	150×75×75 mm
Težina (komad)	0,4084 kg
EAN	8595580574741

NOVO

20

Crna plastična tuš kanalica sa mesinganom rešetkom



APZ10BLACK-BRASS

Tuš kanalica sa rubom za perforirane rešetke, mesing (550, 650, 750, 850, 950 mm)

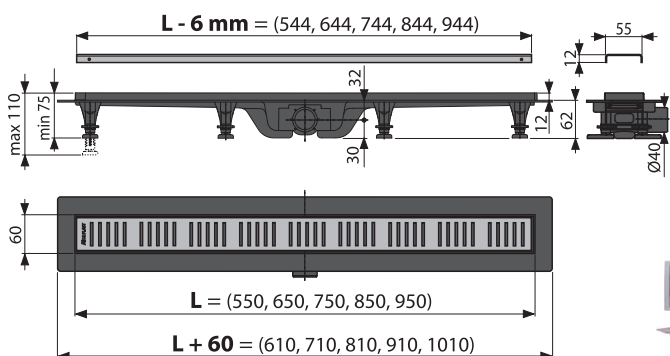

SVE U PAKOVANJU

Količina (pakovanje)	APZ10BLACK-750BRASS	45 kom
Dimenzije (komad)		865x80x145 mm
Težina (komad)		1,8689 kg
EAN		8595580574857

30 l/min

NOVO

21

Dvostruki priključak za spajanje 2 električna uređaja na sifon P157Z

Cenićete ih ne samo u malim stanovima, već i u tehničkim prostorijama ili prilikom postavljanja drugog kućnog aparata. Dvostruki priključak elegantno rešava problem povezivanja dva različita kućna aparata u jedan sifon.

Pogodan za:

- Mašina za sušenje veša
- Kondenzacijski kotao
- Jedinica za rekuperaciju toplote
- Postrojenje za prečišćavanje vode



P157Z



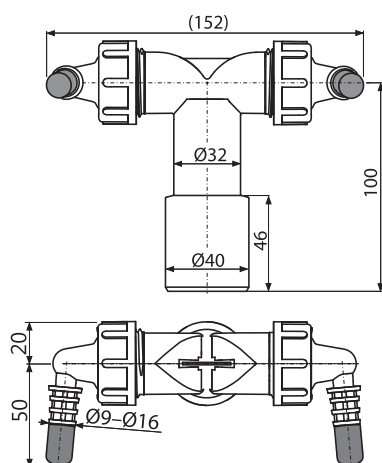









Koleno račva G1"/8-16 sa klapnom

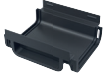

Količina (pakovanje) P157Z	50 kom
Dimenzije (komad)	152x70x120 mm
Težina (komad)	0,1028 kg
EAN	8595580574949

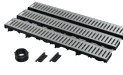











OZNAKA

22













Šifra	Slika	EAN	Opis
AVZ112-R102		8595580572198	Spoljna kanalica 60 mm sa plastičnim ramom i pocinkovanom "C" rešetkom A15
AVZ112-R501		8595580572181	Spoljna kanalica 60 mm sa plastičnim ramom i plastičnom rešetkom A15
AVZ112-R103		8595580574918	Spoljna kanalica 60 mm sa plastičnim ramom i pocinkovanom rešetkom B125
AVZ112-R402		8595580574925	Spoljna kanalica 60 mm sa plastičnim ramom i kompozitnom rešetkom B125
AVZ-P015		8595580572556	Spojni deo spoljnog odvodnog kanala AVZ112
AVZ-P016		8595580572563	Utičnica za priključak na odvodnu cev DN110
AVZ-P017		8595580572570	Čep za zaslepljenje kraja kanalice
AVZ-P018		8595580572587	Ulaz vode DN40
AVZ112-G102		8595580573041	Garažni set 3m (2x završni čep, 1x utičnica DN110)
AVZ112-G501		8595580573058	Garažni set 3 m (2x završni čep, 1x utičnica DN110)
APR3-2110		8595580573768	Industrijski tačkasti slivnik 150x150, inox AISI 304
APR3-2120		8595580573775	Industrijski tačkasti slivnik 150x150, inox AISI 316L
APR4-2111		8595580573423	Industrijski tačkasti slivnik 200x200, inox AISI 304

OZNAKA

23











Šifra	Slika	EAN	Opis
APR4-2121		8595580573454	Industrijski tačkasti slivnik 200×200, inox AISI 316L
APR5-2111		8595580573669	Industrijski tačkasti slivnik 300×300, inox AISI 304
APR5-2121		8595580573676	Industrijski tačkasti slivnik 300×300, inox AISI 316L
APR3-1110		8595580573539	Industrijski tačkasti slivnik 150×150, inox AISI 304
APR3-1120		8595580573546	Industrijski tačkasti slivnik 150×150, inox AISI 316L
APR4-1111		8595580573416	Industrijski tačkasti slivnik 200×200, inox AISI 304
APR4-1121		8595580573447	Industrijski tačkasti slivnik 200×200, inox AISI 316L
APR5-1111		8595580573706	Industrijski tačkasti slivnik 300×300, inox AISI 304
APR5-1121		8595580573713	Industrijski tačkasti slivnik 300×300, inox AISI 316L
APR-R21-150-150		8595580574574	Rešetka za tačkasti slivnik 150×150, inox AISI 304
APR-R22-150-150		8595580574581	Rešetka za tačkasti slivnik 150×150, inox AISI 316L
APR-R21-200-200		8595580574550	Rešetka za tačkasti slivnik 200×200, inox AISI 304
APR-R22-200-200		8595580574567	Rešetka za tačkasti slivnik 200×200, inox AISI 316L

OZNAKA

Šifra	Slika	EAN	Opis
APR-R21-300-300		8595580574598	Rešetka za tačkasti slivnik 300×300, inox AISI 304
APR-R22-300-300		8595580574604	Rešetka za tačkasti slivnik 300×300, inox AISI 316L
APR-R31-150-150		8595580575922	Rešetka za tačkasti slivnik 150×150, inox AISI 304
APR-R32-150-150		8595580575939	Rešetka za tačkasti slivnik 150×150, inox AISI 316L
APR-R31-200-200		8595580575762	Rešetka za tačkasti slivnik 200×200, inox AISI 304
APR-R32-200-200		8595580575786	Rešetka za tačkasti slivnik 200×200, inox AISI 316L
APR-R31-300-300		8595580575779	Rešetka za tačkasti slivnik 300×300, inox AISI 304
APR-R32-300-300		8595580575793	Rešetka za tačkasti slivnik 300×300, inox AISI 316L
APR6-2311-135		8595580573478	Industrijski tačkasti slivnik sa ulazom 250×250-135, inox AISI 304
APR6-2321-135		8595580573492	Industrijski tačkasti slivnik sa ulazom 250×250-135, inox AISI 316L
APR6-2211-135		8595580573508	Industrijski tačkasti slivnik sa ulazima 250×250-135, inox AISI 304
APR6-2221-135		8595580573515	Industrijski tačkasti slivnik sa ulazima 250×250-135, inox AISI 316L
APR6-2211-210		8595580573607	Industrijski tačkasti slivnik sa ulazima 250×250-210, inox AISI 304





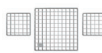
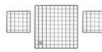







OZNAKA

25

Šifra	Slika	EAN	Opis
APR6-2221-210		8595580573614	Industrijski tačkasti slivnik sa ulazima 250x250-210, inox AISI 316L
APR6-1311-135-L		8595580574499	Industrijski tačkasti slivnik sa ulazom 250x250-135, inox AISI 304
APR6-1311-135-P		8595580574512	Industrijski tačkasti slivnik sa ulazom 250x250-135, inox AISI 304
APR6-1321-135-L		8595580574505	Industrijski tačkasti slivnik sa ulazom 250x250-135, inox AISI 316L
APR6-1321-135-P		8595580574529	Industrijski tačkasti slivnik sa ulazom 250x250-135, inox AISI 316L
APR6-1211-135		8595580573461	Industrijski tačkasti slivnik sa ulazima 250x250-135, inox AISI 304
APR6-1221-135		8595580573485	Industrijski tačkasti slivnik sa ulazima 250x250-135, inox AISI 316L
APR6-1211-210		8595580573621	Industrijski tačkasti slivnik sa ulazima 250x250-210, inox AISI 304
APR6-1221-210		8595580573638	Industrijski tačkasti slivnik sa ulazima 250x250-210, inox AISI 316L
APR-R21-250-250-1		8595580574680	Rešetka za tačkasti slivnik sa ulazom APR6, inox AISI 304
APR-R22-250-250-1		8595580574673	Rešetka za tačkasti slivnik sa ulazom APR6, inox AISI 316L
APR-R21-130-135-2		8595580574659	Rešetka za tačkasti slivnik sa ulazima APR6, inox AISI 304
APR-R22-130-135-2		8595580574666	Rešetka za tačkasti slivnik sa ulazima APR6, inox AISI 316L

OZNAKA

26













Šifra	Slika	EAN	Opis
APR-R21-1000-210		8595580574611	Rešetka za industrijsku kanalicu 1 m, inox AISI 304
APR-R22-1000-210		8595580574628	Rešetka za industrijsku kanalicu 1 m, inox AISI 316L
APR-R31-250-250-1		8595580575809	Rešetka za tačkasti slivnik sa ulazom APR6, inox AISI 304
APR-R32-250-250-1		8595580575816	Rešetka za tačkasti slivnik sa ulazom APR6, inox AISI 316L
APR-R31-130-135-2		8595580575823	Rešetka za tačkasti slivnik sa ulazima APR6, inox AISI 304
APR-R32-130-135-2		8595580575830	Rešetka za tačkasti slivnik sa ulazima APR6, inox AISI 316L
APR-R31-1000-210		8595580575861	Rešetka za industrijsku kanalicu 1 m, inox AISI 304
APR-R32-1000-210		8595580575878	Rešetka za industrijsku kanalicu 1 m, inox AISI 316L
APR6-0211-135		8595580573560	Industrijska kanalica 1 m, inox AISI 304
APR6-0221-135		8595580573577	Industrijska kanalica 1 m, inox AISI 316L
APR6-0211-210		8595580573584	Industrijska kanalica 1 m, inox AISI 304
APR6-0221-210		8595580573591	Industrijska kanalica 1 m, inox AISI 316L
APR-R21-1000-135		8595580574635	Rešetka za industrijsku kanalicu 1 m, inox AISI 304

OZNAKA

Šifra	Slika	EAN	Opis
APR-R22-1000-135		8595580574642	Rešetka za industrijsku kanalicu 1 m, inox AISI 316L
APR-R31-1000-135		8595580575847	Rešetka za industrijsku kanalicu 1 m, inox AISI 304
APR-R32-1000-135		8595580575854	Rešetka za industrijsku kanalicu 1 m, inox AISI 316L
APR6-0211-135R		8595580574086	Industrijska ugaona kanalica 1 m, inox AISI 304
APR6-0221-135R		8595580574079	Industrijska ugaona kanalica 1 m, inox AISI 316L
APR6-0211-210R		8595580574055	Industrijska ugaona kanalica, 1 m, inox AISI 304
APR6-0221-210R		8595580574062	Industrijska ugaona kanalica 1 m, inox AISI 316L
APR-R21-865-135		8595580574727	Rešetka za ugaonu kanalicu, inox AISI 304
APR-R22-865-135		8595580574710	Rešetka za ugaonu kanalicu, inox AISI 316L
APR-R21-790-210		8595580574697	Rešetka za ugaonu kanalicu, inox AISI 304
APR-R22-790-210		8595580574703	Rešetka za ugaonu kanalicu, inox AISI 316L
APR-R31-865-135		8595580575885	Rešetka za ugaonu kanalicu, inox AISI 304
APR-R32-865-135		8595580575892	Rešetka za ugaonu kanalicu, inox AISI 316L













OZNAKA

28

Šifra	Slika	EAN	Opis
APR-R31-790-210		8595580575908	Rešetka za ugaonu kanalicu, inox AISI 304
APR-R32-790-210		8595580575915	Rešetka za ugaonu kanalicu, inox AISI 316L
APR6-P101-135		8595580573805	Čelo za industrijsku kanalicu 135, inox AISI 304
APR6-P201-135		8595580573812	Čelo za industrijsku kanalicu 135, inox AISI 316L
APR6-P101-210		8595580573782	Čelo za industrijsku kanalicu 210, inox AISI 304
APR6-P201-210		8595580573799	Čelo za industrijsku kanalicu 210, inox AISI 316L
APR7-2311-20		8595580574475	Industrijski tačkasti slivnik sa prorezanim ulazom 250x250, inox AISI 304
APR7-2321-20		8595580574482	Industrijski tačkasti slivnik sa prorezanim ulazom 250x250, inox AISI 316L
APR7-2211-20		8595580573683	Industrijski tačkasti slivnik sa prorezanim ulazima 250x250, inox AISI 304
APR7-2221-20		8595580573690	Industrijski tačkasti slivnik sa prorezanim ulazima 250x250, inox AISI 316L
APR7-1211-20		8595580573744	Industrijski tačkasti slivnik sa prorezanim ulazima 250x250, inox AISI 304
APR7-1221-20		8595580573751	Industrijski tačkasti slivnik sa prorezanim ulazima 250x250, inox AISI 316L
APR7-1311-20-L		8595580573720	Sifon industrial cu fantă 250x250, prorezani ulaz AISI 304











OZNAKA

29

Šifra	Slika	EAN	Opis
APR7-1311-20-P		8595580573874	Industrijski tačkasti slivnik sa prorezanim ulazom 250x250, inox AISI 304
APR7-1321-20-L		8595580573737	Sifon industrial cu fantă 250x250, prorezani ulaz AISI 316L
APR7-1321-20-P		8595580573881	Sifon industrial cu fantă 250x250, prorezani ulaz AISI 316L
APR-R21-250-250		8595580574536	Rešetka za industrijske podne slivnike APR7, inox AISI 304
APR-R22-250-250		8595580574543	Rešetka za industrijske podne slivnike APR7, inox AISI 316L
APR-R31-250-250		8595580575748	Rešetka za industrijske podne slivnike APR7, inox AISI 304
APR-R32-250-250		8595580575755	Rešetka za industrijske podne slivnike APR7, inox AISI 316L
APR7-0211-20R		8595580574093	Industrijska ugaona prorezana kanalica 1 m, inox AISI 304
APR7-0221-20R		8595580574109	Industrijska ugaona prorezana kanalica 1 m, inox AISI 316L
APR7-0211-20		8595580573652	Industrijska prorezana kanalica 1 m, inox AISI 304
APR7-0221-20		8595580573645	Industrijska prorezana kanalica 1 m, inox AISI 316L
APR7-P101-20		8595580573829	Čelo za prorezani slivnik, inox AISI 304
APR7-P102-20		8595580573836	Čelo za prorezani slivnik, inox AISI 316L

OZNAKA

30

Šifra	Slika	EAN	Opis
A68		8594045936117	WC daska – dečiji uložak
APV31BLACK		8595580574895	Podni slivnik 105×105/50 mm bočni, nerđajuća rešetka crna-mat, sifon sa zatvaračem mirisa SMART
APV32BLACK		8595580574956	Podni slivnik 105×105/50 mm vertikalni spoj, nerđajuća rešetka crna-mat, sifon sa zatvaračem mirisa SMART
MPV004-BLACK		8595580574734	Rešetka 102×102 mm nerđajući čelik, crna-mat
A396BLACK		8595580574741	Gornji deo sifona za umivaonik 5/4" metalni, veliki čep, za umivaonike bez preliva crna-mat
APZ10BLACK-550BRASS		8595580574888	Tuš kanalica sa rubom za perforiranu rešetku, mesing
APZ10BLACK-650BRASS		8595580574840	Tuš kanalica sa rubom za perforiranu rešetku, mesing
APZ10BLACK-750BRASS		8595580574857	Tuš kanalica sa rubom za perforiranu rešetku, mesing
APZ10BLACK-850BRASS		8595580574864	Tuš kanalica sa rubom za perforiranu rešetku, mesing
APZ10BLACK-950BRASS		8595580574871	Tuš kanalica sa rubom za perforiranu rešetku, mesing
P157Z		8595580574949	Koleno račva G1"/8–16 sa klapnom

Alcaplastov tim specijalista je uvek
na usluzi da pomogne oko dizajna, instalacije
i projektnih cena.

Češki proizvod
ISO 9001:2015



Alca PLAST®

CZECH REPUBLIC

Alca plast, s. r. o.
Bratislavská 2846, 690 02 Břeclav
tel.: +420 519 821 117
tel.: +420 519 821 041 – export
fax: +420 519 821 083
e-mail: alcaplast@alcaplast.cz
www.alcaplast.cz

SERBIA

Alca plast Balkan d.o.o.
Železnička 75
11300 Smederevo
M: +381 64 594 97 57
e-mail: b.miljkovic@alcaplast.cz
www.alcaplast.rs